

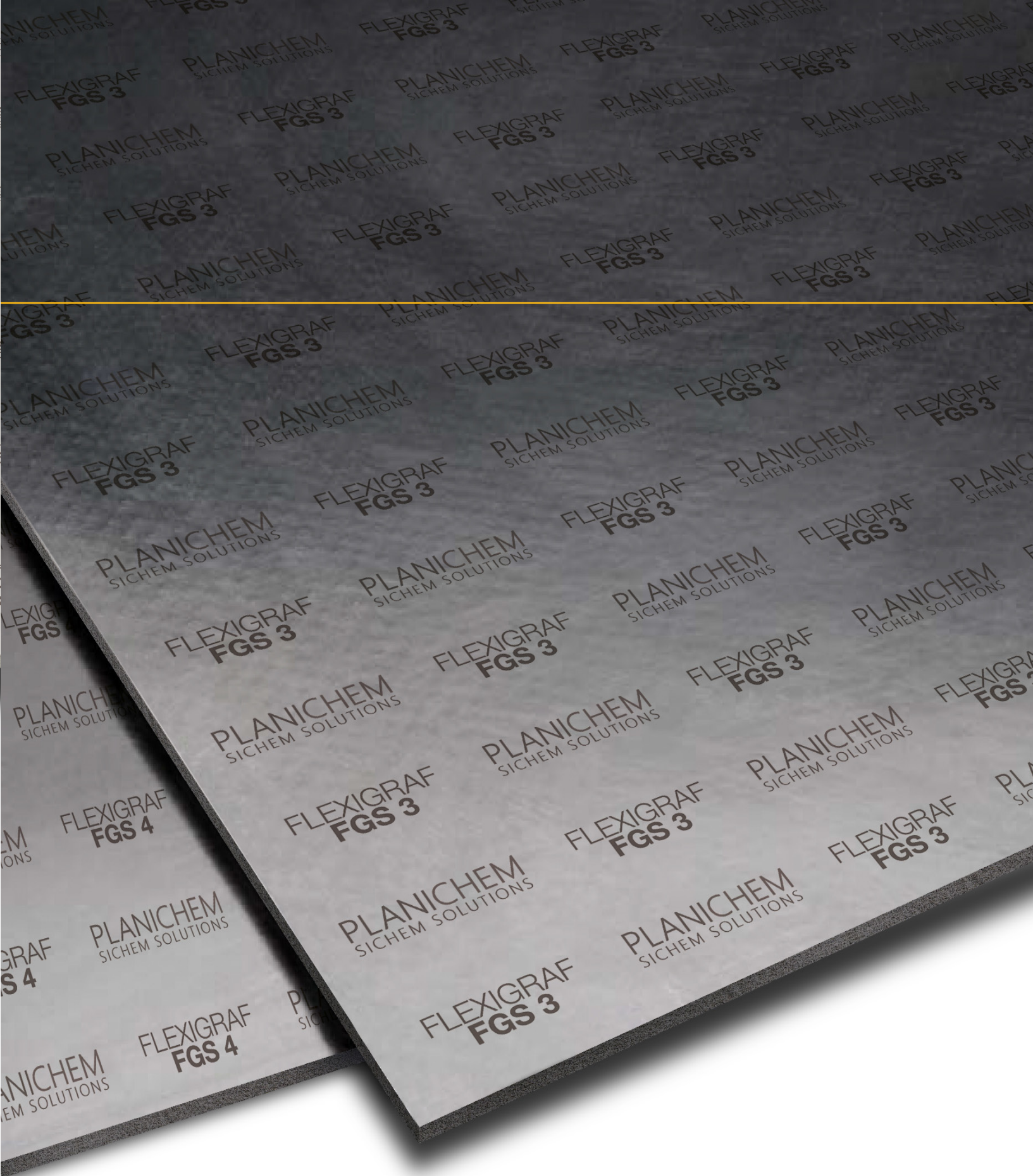

G A S K E T

B R O C H U R E

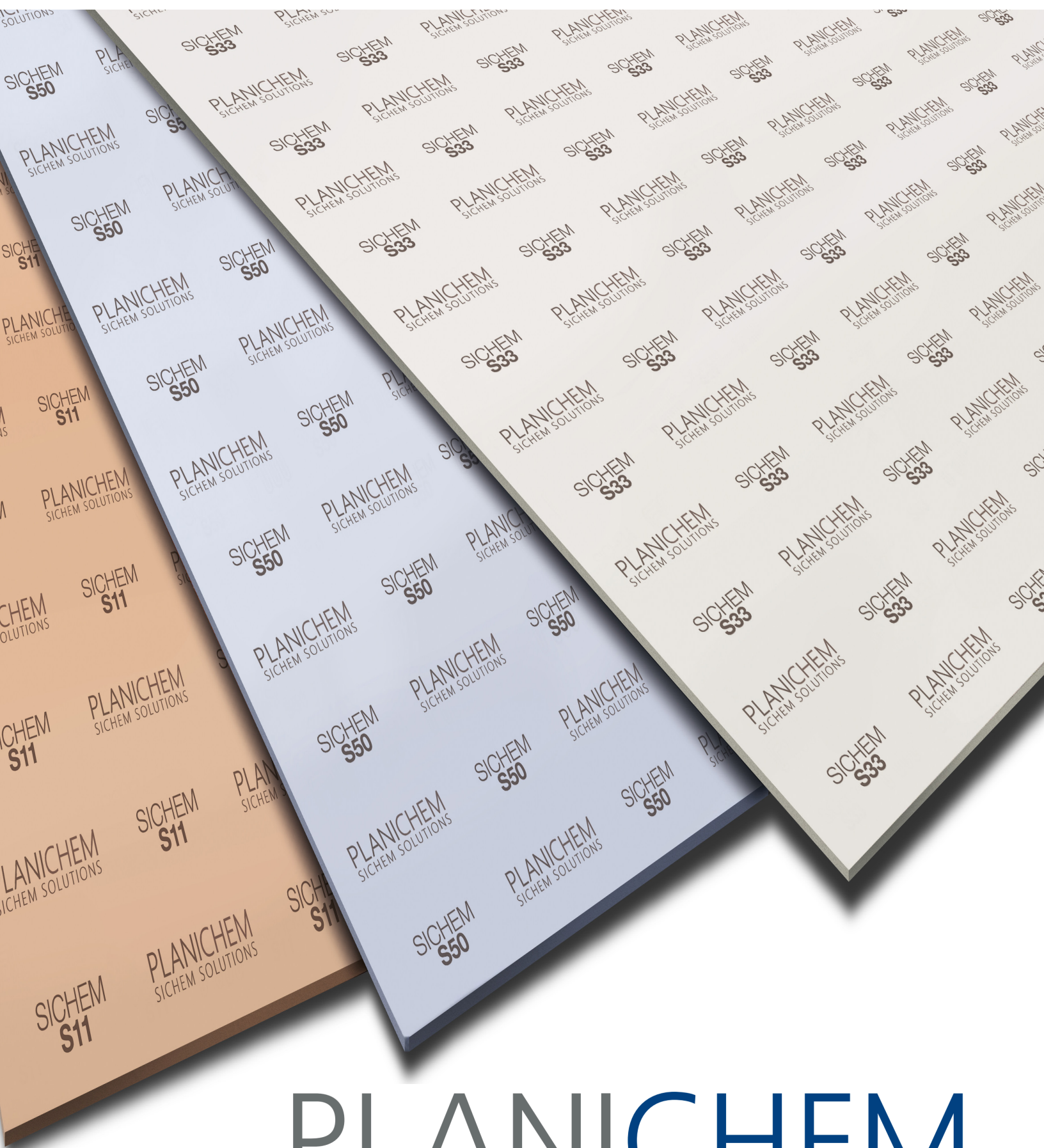

PLANICHEM

SICHEM SOLUTIONS

THE FUTURE OF HIGH PERFORMANCE SEALING HAS ARRIVED

Patented **FISHBONE™**

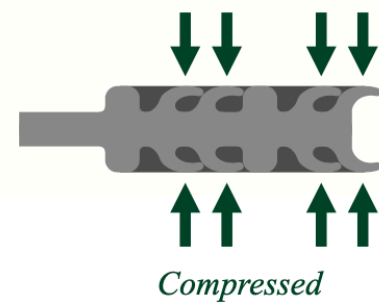
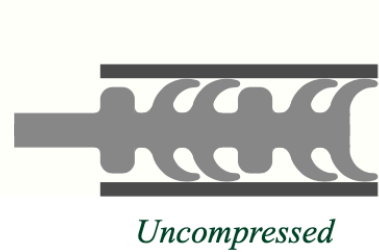

- **1,000,000** times lower leakage than TA-LUFT Test limit
- **25** times lower leakage than Chevron Fugitive Emissions Test limit
- **Pass** API 6FB Fire Test

Heat Exchanger Fishbone™ Gaskets Quotation From

Heat Exchanger Fishbone Gaskets Configuration Styles (please provide the drawings if other styles applicable)

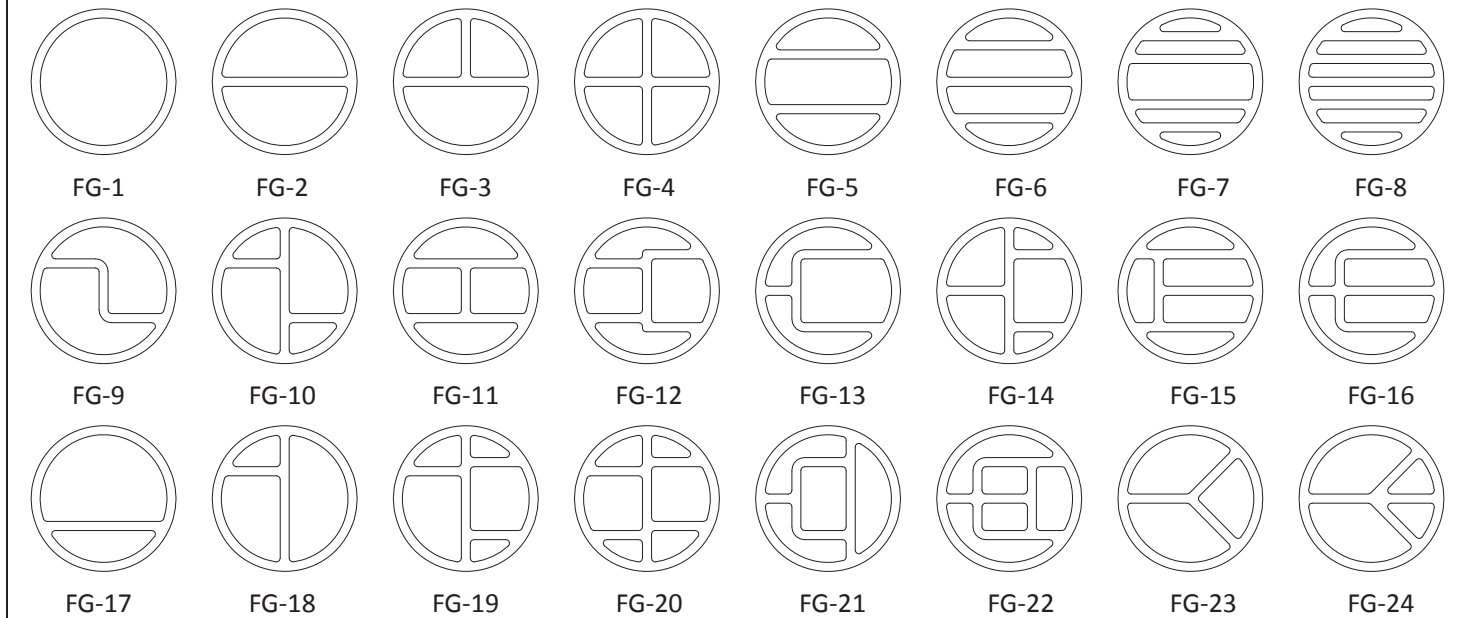

Heat Exchanger Fishbone Gaskets Sealing Cross Section (The number of fishbone will be determined by sealing width.)

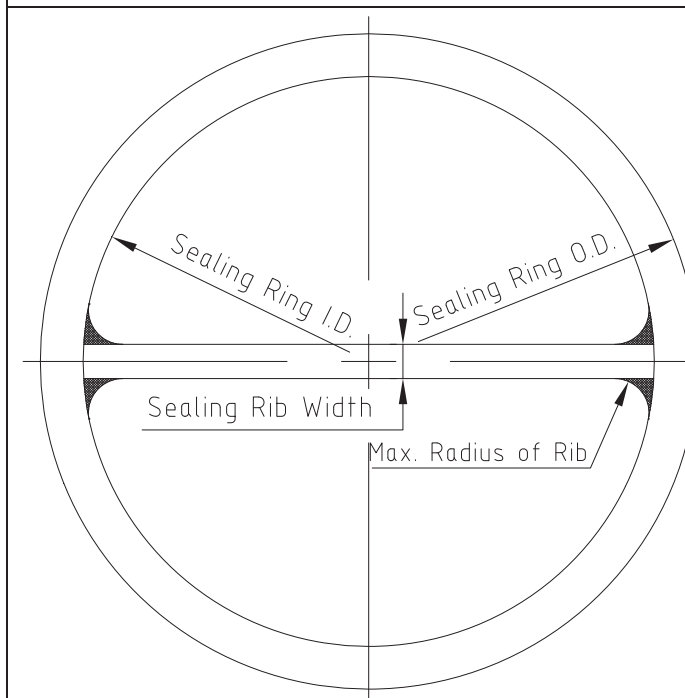
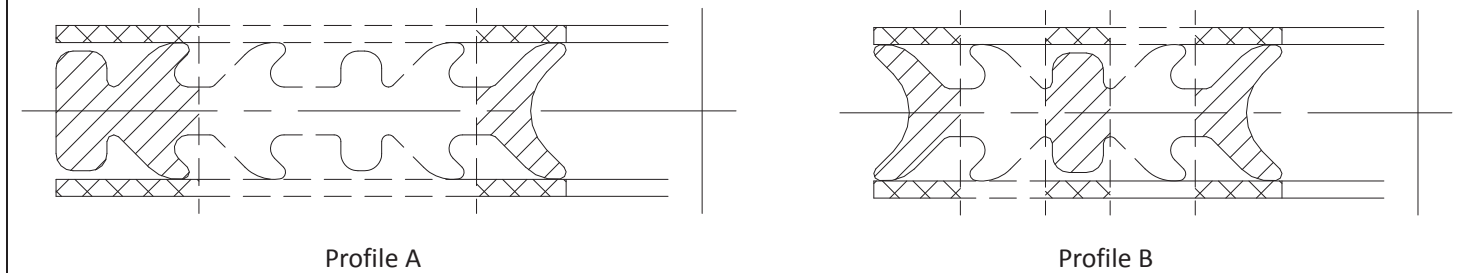

Configuration Styles:		FG-	
Sealing Ring Cross Section:		Profile A <input checked="" type="radio"/> Profile B <input type="radio"/>	
Sealing Ring O.D. :		mm	
Sealing Ring I.D. :		mm	
Sealing Rib Width:		mm	
Max. Radius of Rib:		mm	
H1:	mm	H3:	mm
H2:	mm	H4:	mm
Gaskets Thickness			
3.5mm <input type="radio"/>	4.0mm <input type="radio"/>	4.5mm <input type="radio"/>	5.0mm <input checked="" type="radio"/>
Metal Materials			
304 SS <input type="radio"/>	316 SS <input type="radio"/>	321 SS <input type="radio"/>	317L SS <input type="radio"/>
304L SS <input type="radio"/>	316L SS <input type="radio"/>	Other Materials <input checked="" type="radio"/>	
Non-metallic Sealing Materials			
Flexible Graphite <input type="radio"/>		PTFE <input checked="" type="radio"/>	



Asbestos Free Gasket Materials

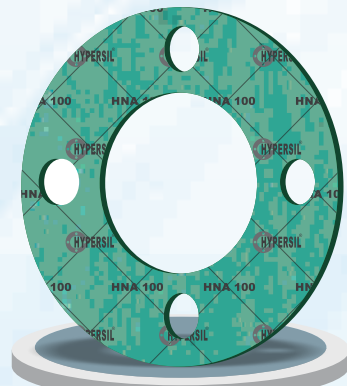

HNA-100

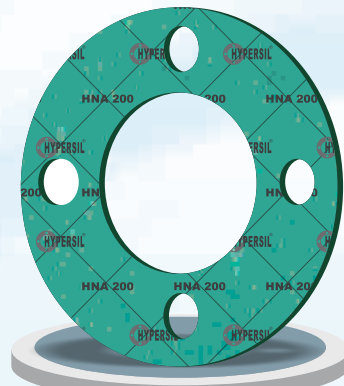

HNA-200

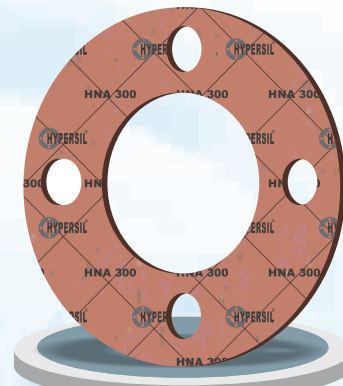

HNA-300



HNA-400



HNA-Acid



HNA-600GF

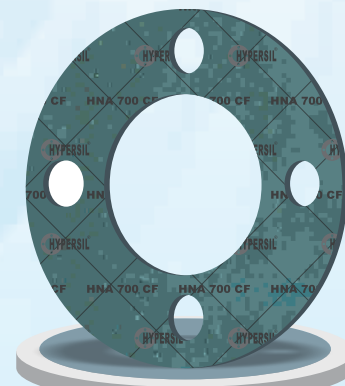

HNA-700CF

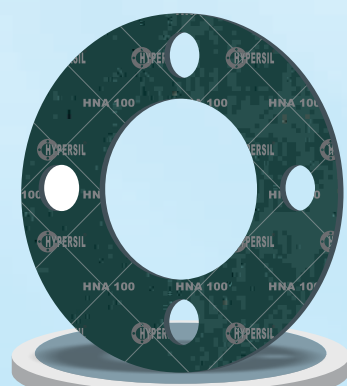

HNA-100 Metallic

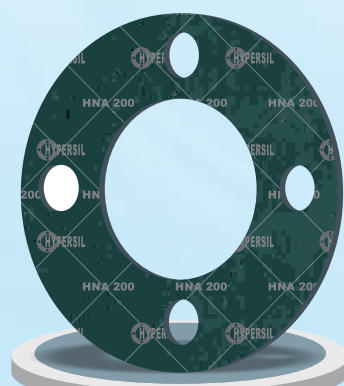

HNA-200 Metallic

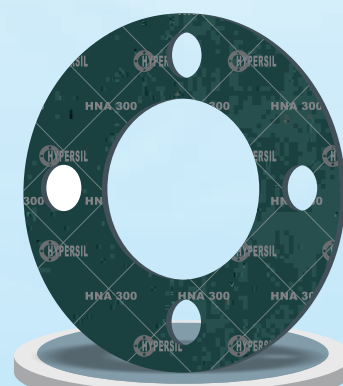

HNA-300 Metallic

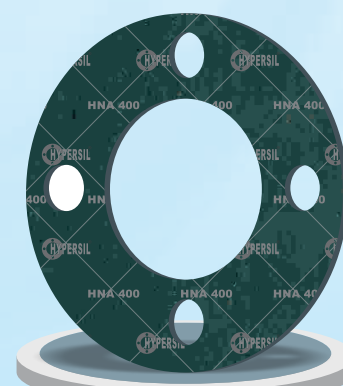

HNA-400 Metallic

FABRIC REINFORCED RUBBER

AB-3210 NEOPRENE DIAPHRAGM

FEATURES

- One or two plies of 14.0 oz nylon
- Premium grade neoprene compound
- ASTM Grade.

GRADE	Industrial
FINISH	Smooth
POWDER	Yes
TRIMMED	Yes
COLOR	Black

	GAUGE IN (MM)	WIDTH IN (MM)	SURFACE/ROLL SFT (M ²)	LENGTH/ROLL LFT (M)	WEIGHT/ROLL LBS (KG)
234-04-542	1/16 (1.60) 1 PLY	54 (1371.6)	450 (41.8)	100 (30.48)	217 (98.4)
234-08-542	1/8 (3.20) 1 PLY	54 (1371.6)	225 (20.9)	50 (15.24)	205 (93)
236-08-542	1/8 (3.20) 2 PLY	54 (1371.6)	225 (20.9)	50 (15.24)	208 (94.3)
236-12-542	3/16 (4.80) 2 PLY	54 (1371.6)	113 (10.49)	25 (7.62)	154 (69.9)
236-16-542	1/4 (6.35) 2 PLY	54 (1371.6)	113 (10.49)	25 (7.62)	214 (97.1)

¹ Made to order



Flange management and joint integrity



100%

leak free start-up record

DISC SPRINGS



SPRAY SHIELD

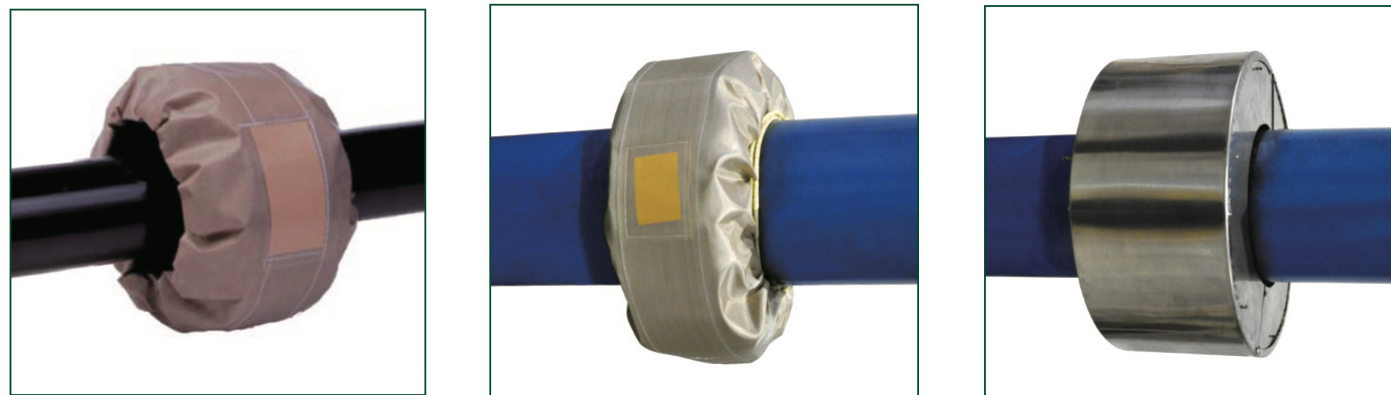

Environmentally Friendly Solvent Free Process

LEAKBLOK[®]



Improving Reliability.

Delivering Quality.

Developing Consistency.

Creating Perfection.

Branches

Cape Town

Durban

Johannesburg

Port Elizabeth

Mozambique

Nelspruit

Swaziland

Zimbabwe

www.sizonkegroup.co.za

support@sizonketrading.co.za